

If you're doing advanced version of exhaust pipes - cut out these gray rectangles after assy

If you're doing advanced version cut out these gray rectangles after assy

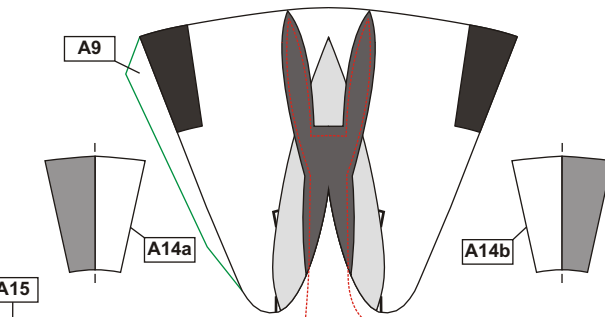

Cut out this dark gray area after assy.

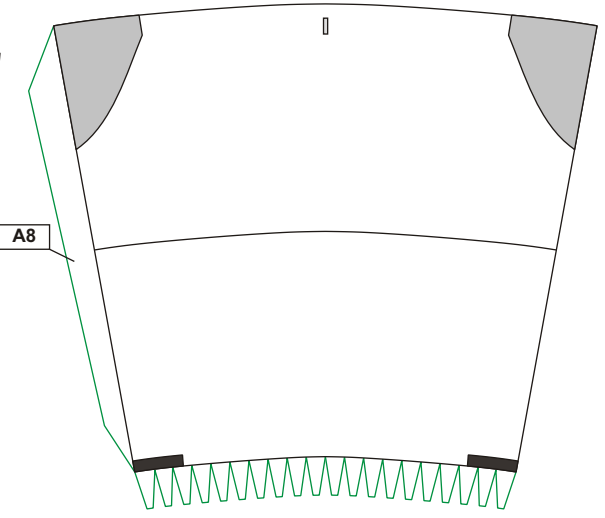
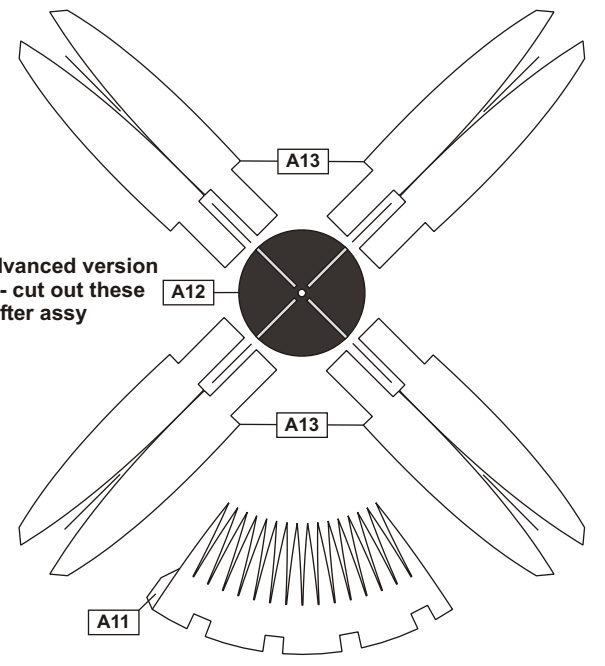
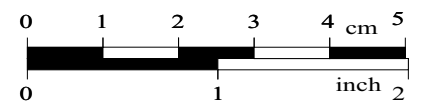
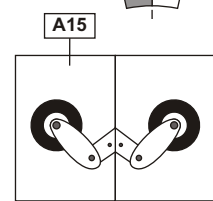
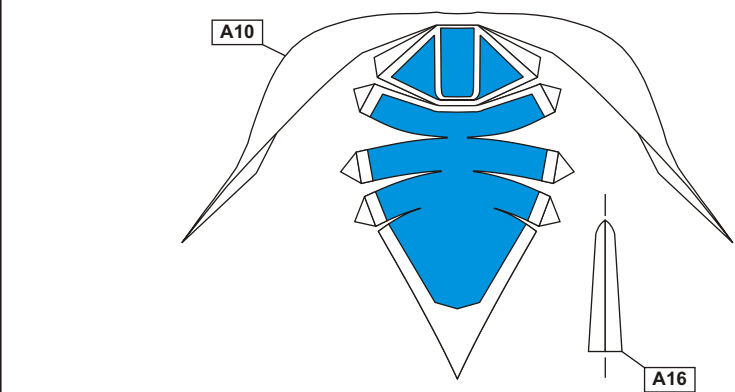

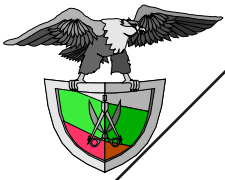

After assemble this part, cut out marked dark gray area. You have to attach this one to the basic fuselage, after attaching the wings

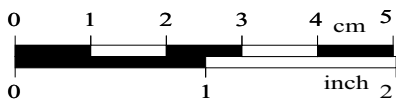
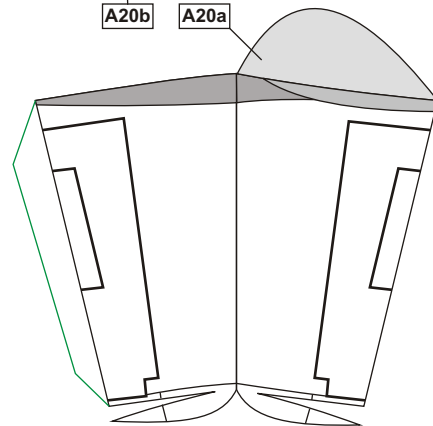
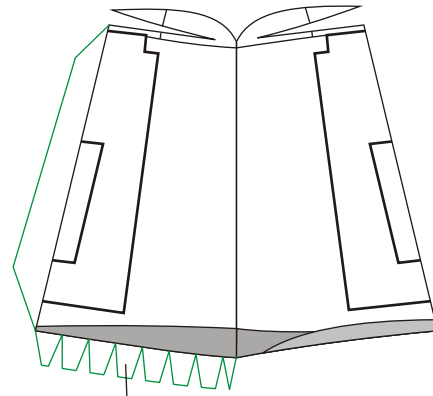
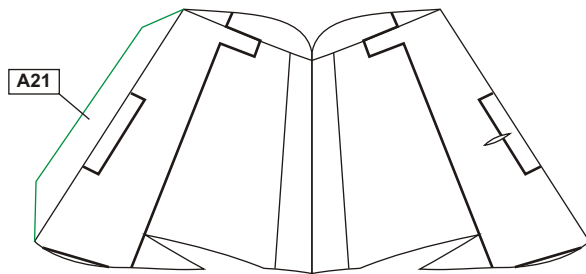
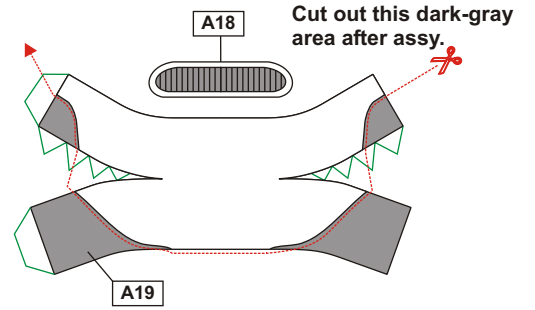
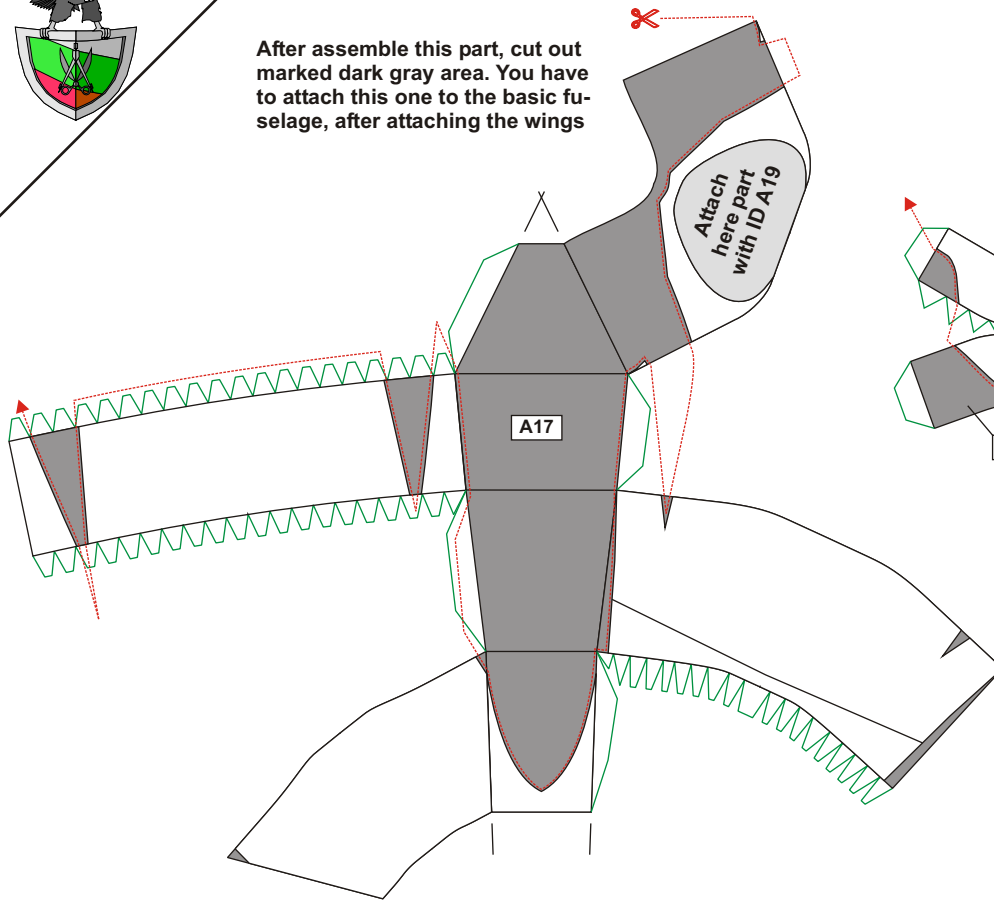

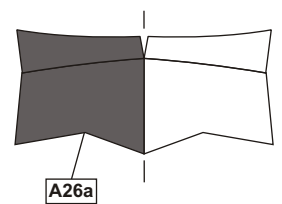
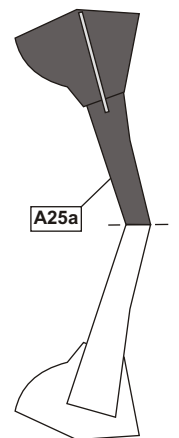
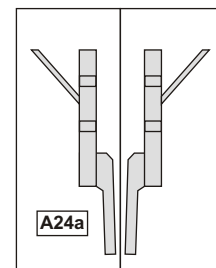
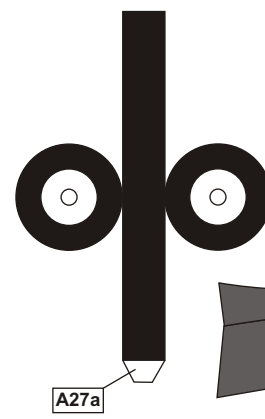
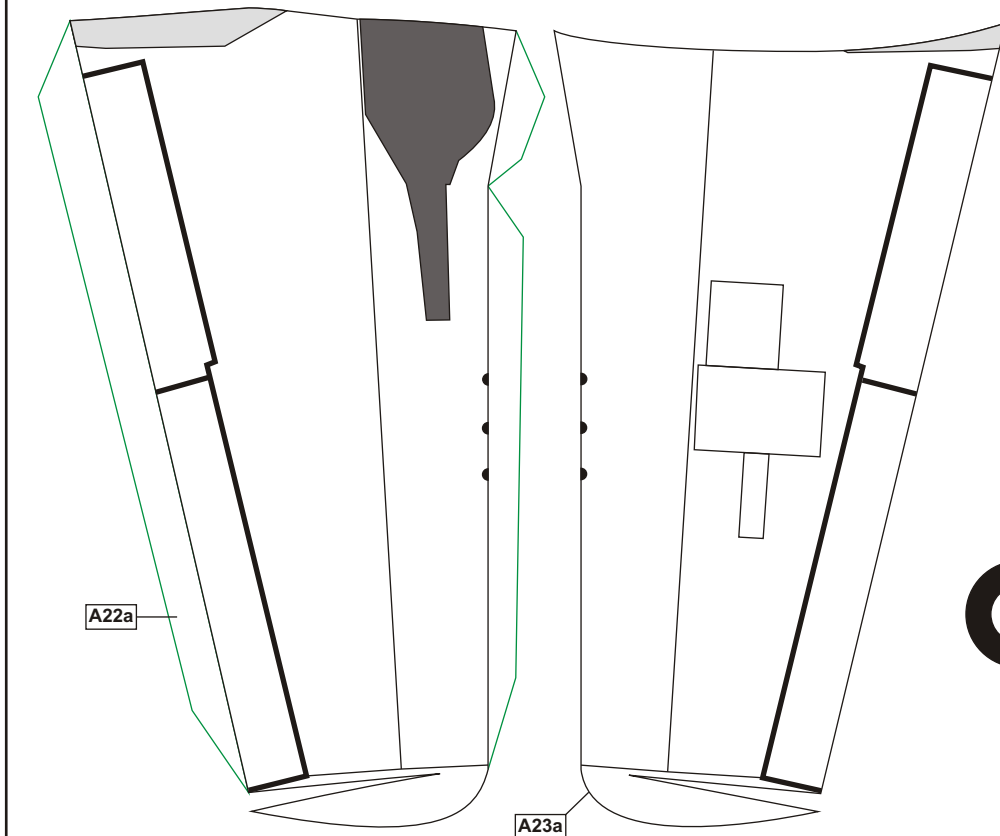
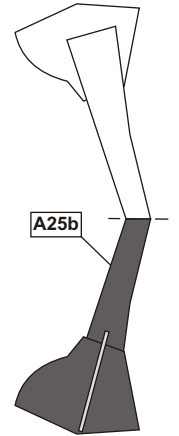
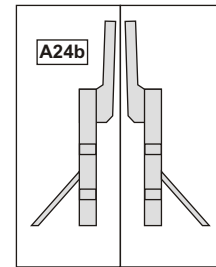
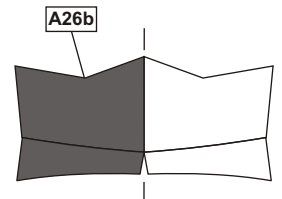
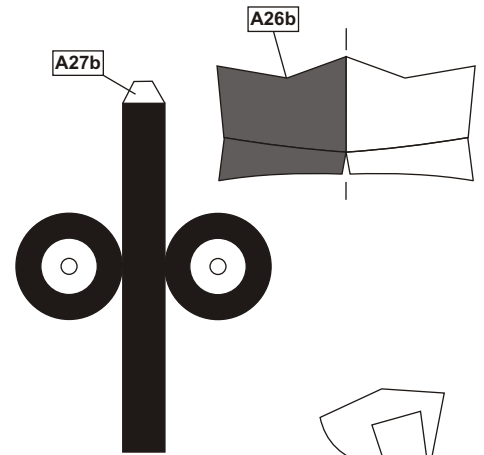
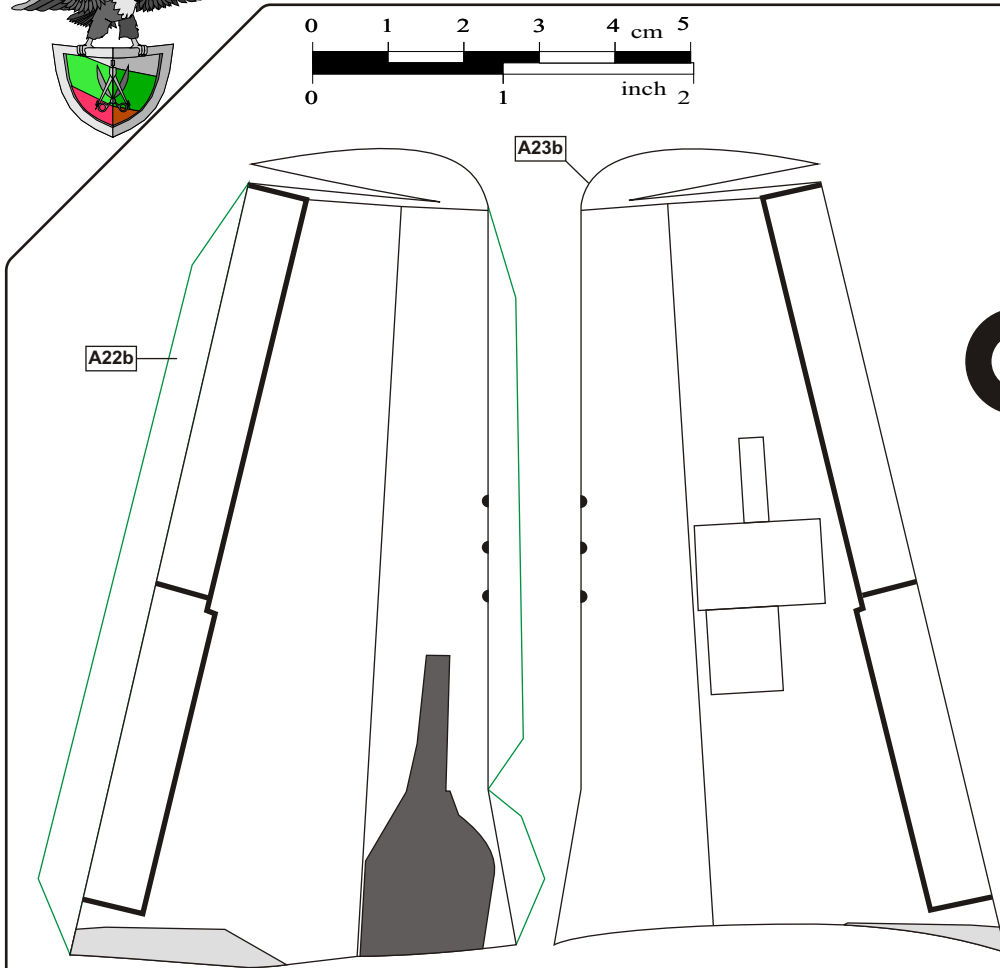
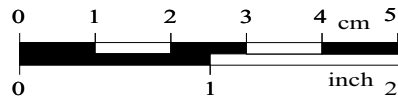
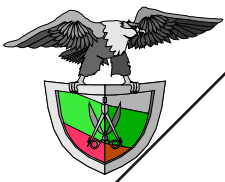

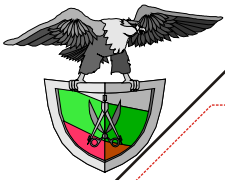

After printing, glue this area to a sheet of thick cardboard

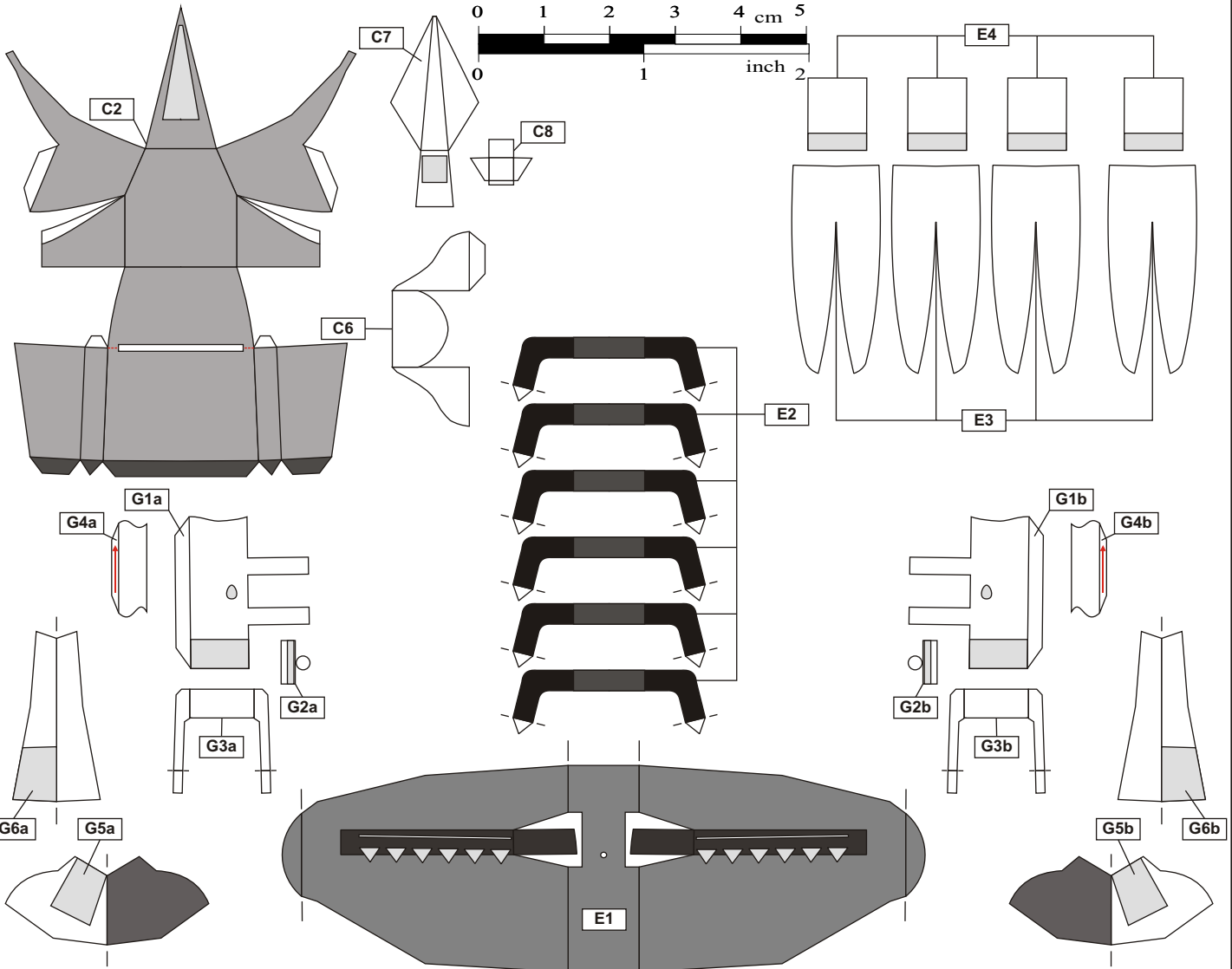
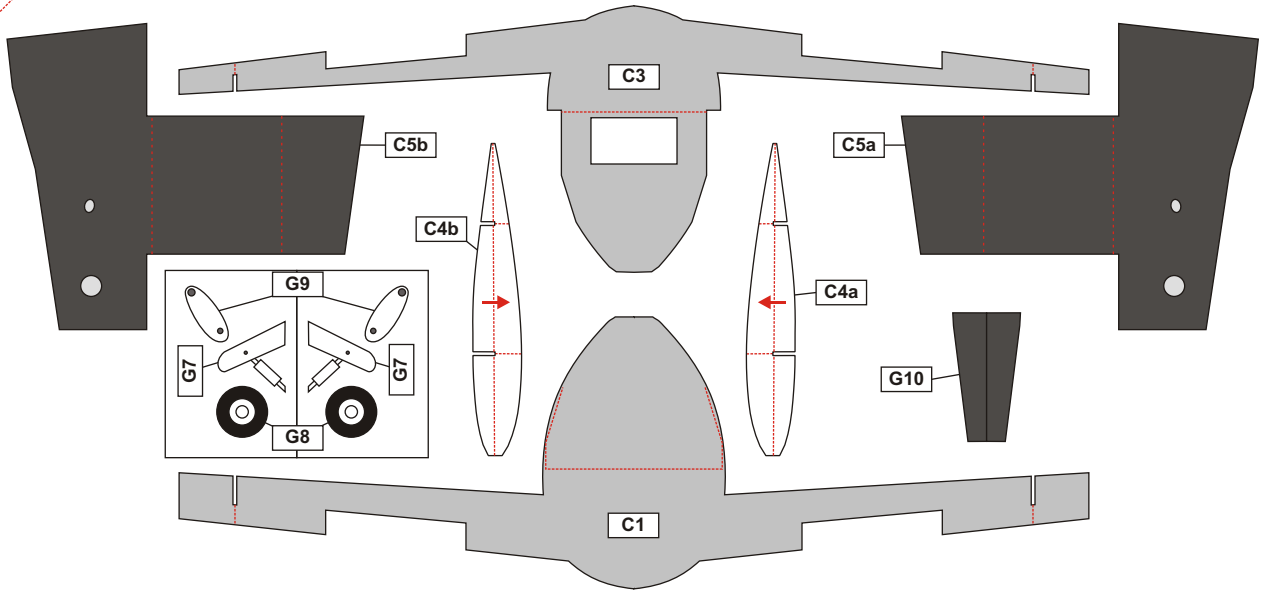

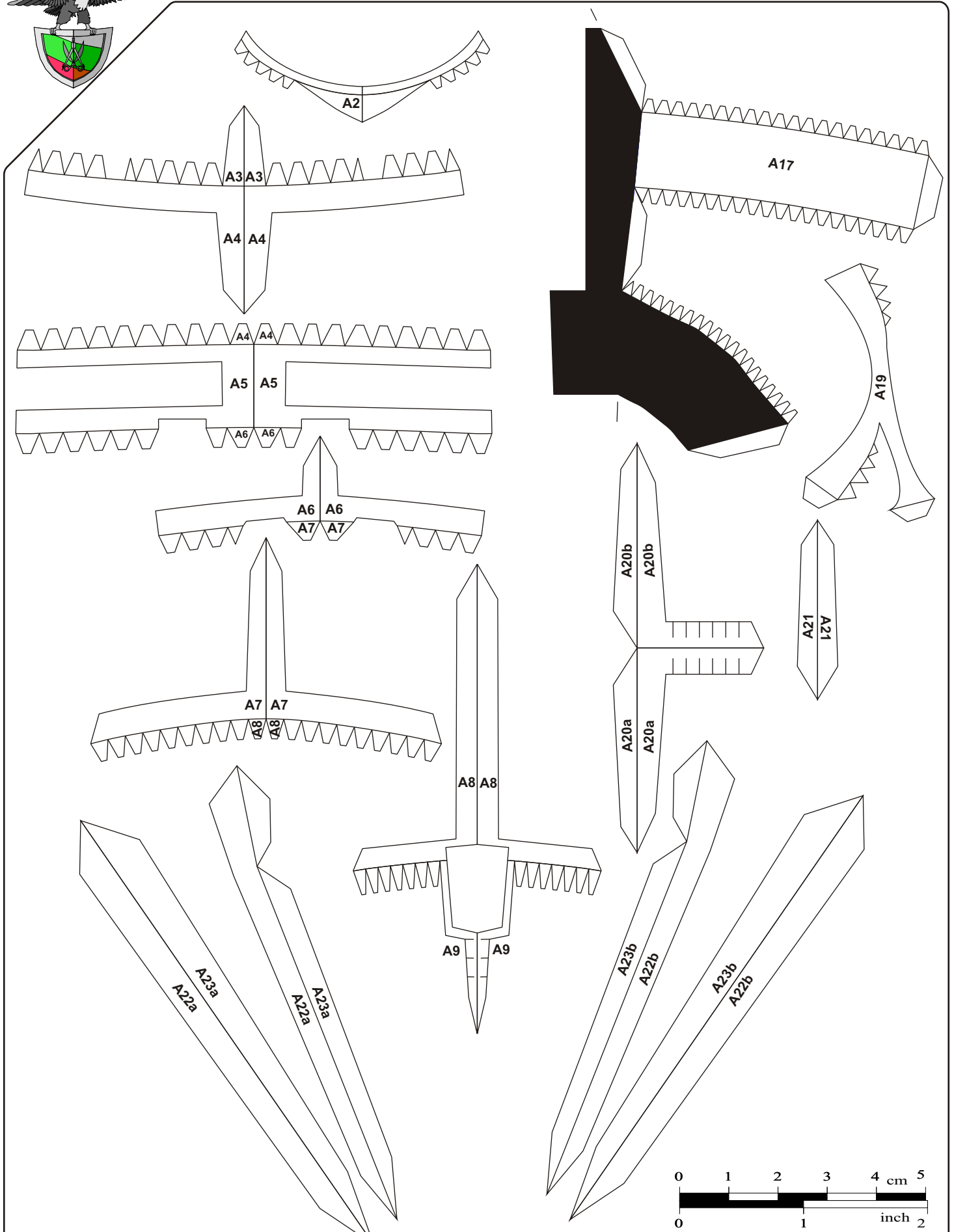
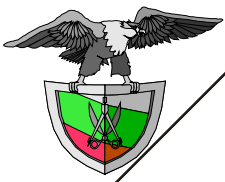

CAC CA-15 'Kangaroo' Scale 1:48

Elements